



Views from

the

Hill Top

September 1, 2021

HAPPY BIRTHDAY



Maxine Foss- September 14th

Marlene Hillstead- September 21st

Madeline Richards- September 24th



**Don't forget to use
your Hill Top Bucks
for the canteen!**



Kylans Kanteen

Did you know?
We have a canteen that
comes to your door?
Coupons to purchase items
off the cart are \$1 each and
can be bought in the office.
And best of all, all food or
drink items are available
are for only \$1 each!
What a bargain!



September 15th – indoor concert
(Friends of Mel)

September 24th - Outdoor Concert
(Capo)

September 27th- Outdoor Concert (Keith
and Gary)

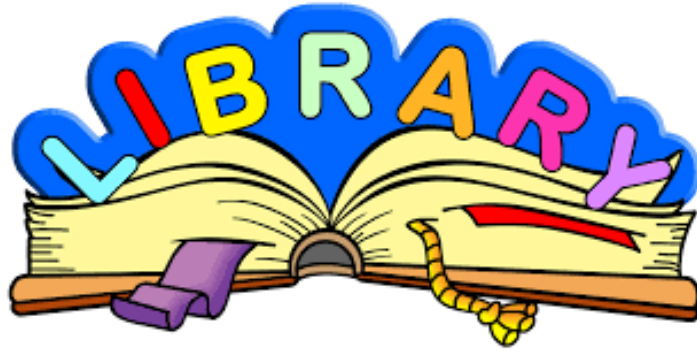

*Did you know that we have our own Library?
We have some Large Print books available as well as Mystery, Romance,
Detective, Inspirational & Lots of others.*

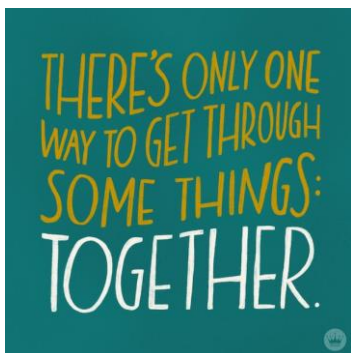

***DUE TO THE UNCERTAIN TIMES WE WILL
KEEP YOU INFORMED WITH DAILY ACTIVITY
PROGRAMS AND CHURCH SERVICES.***



Welcome to our Hill Top Manor Family Lucille Mazenc



Good Luck in your new home Elsie!

*Good
bye
& Good
Luck!*



Outdoor Music

The residents enjoyed the nice weather and the music 😊



Greedy Afternoons!





Tim Horton's Drive thru!





UTUMN

The First Day of Autumn is on
Tuesday, September 22.



GRANDPARENTS DAY (September 13th)

Grandparents bestow upon their
grandchildren
the strength and wisdom that time
and experience have given them.

Grandchildren bless their
Grandparents
with a youthful vitality and innocence
that helps them stay young at heart



forever.

Together they create a chain of love

linking the past with the future.

The chain may lengthen, but it will never part!



SOMETHING TO THINK ABOUT:

If you mix flour and water together, you get glue.

Add eggs, sugar and shortening, and you get a

cake.

Where did the glue go???



SEPTEMBER

The last days of summer and the first days of fall are a special time of the year! It's a time to gather up the rest of the harvest and prepare for the winter months.

“There are flowers enough in the summertime,
More flowers than I can remember –
But none with the purple, gold, and red
That dye the flowers of September!”

(Mary Howitt (1799-1888))



September's name comes from the Latin word septem, meaning “seven.” This month had originally been the seventh month of the early Roman calendar.



SMILES ARE CONTAGIOUS

Smiling is infectious,
You catch it like the flu.
When someone smiled at me today,
I started smiling too!



I passed around the corner
And someone saw my grin,
When he smiled, I realized
I'd passed it on to him!
I thought about that smile,
Then realized its worth;
A single smile, just like mine
Could travel round the earth,
So, if you feel a smile begin
Don't leave it undetected.
Let's start an epidemic quick,
And get the world infected!



A CHILD'S DEFINITION OF A FORTUNE COOKIE – A COOKIE WITH MAIL INSIDE!

A highway patrolman pulled alongside a speeding car on the freeway. Glancing at the car, he was astonished to see that the woman behind the wheel was knitting! Realizing that she was oblivious to his flashing lights and siren, the trooper cranked down his window, turned on his bullhorn, and yelled, "**PULL OVER!**"
"No," the woman yelled back, "It's a **SCARF**".



CANADIAN LABOUR DAY

Labour Day is a statutory national holiday celebrated throughout Canada on the first Monday in September. The origins of Labour Day in Canada can be traced back to a printer's revolt in 1872 in Toronto when labourers tried to establish a maximum 54-hour workweek. At that time, any union activity was considered illegal and the organizers were jailed. Protest marches of over 10,000 formed in response. This eventually led



to the Prime Minister Sir John A. Macdonald repealing the anti-union laws and arranging the release of the organizers as well. The date was officially declared as a national holiday in Canada on July 23rd 1894 by the government of Prime Minister John Thompson. While some Labour Day parades and picnics are organized by unions, most Canadians simply regard Labour Day as the Monday of the last long weekend of summer.

.....

HARVEST IN SOUTHERN SASKATCHEWAN

Crop District 2 – Weyburn, Milestone, Moose Jaw, Regina & Qu'Appelle areas;

* Saskatchewan Agriculture says four per cent of the 2020 crop is harvested. Warm temperatures are causing crops to rapidly develop and ripen, Saskatchewan Agriculture reported Thursday, as farmers continue to make progress on the harvest.

* Four per cent of the crop is combined, slightly behind the 5-year average of five per cent for this time of year, according to the weekly crop report.

* Another six per cent of the crop is swathed or ready to straight-cut. The five-year average for this time of year is eight per cent.

* Five per cent of the crop in the southeast, two per cent in the central regions, and less than one per cent in the northern regions is combined.

* Sixty-two per cent of fall rye, 37 per cent of winter wheat, 22 per cent of field peas, 19 per cent of lentils and six per cent of barley is in the bin, and three per cent of canola has been swathed or is ready to straight-cut.

* Sask Ag said there are reports of premature ripening of crops due to the heat, which has also caused some crop damage.

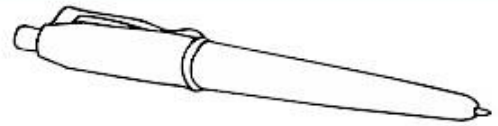
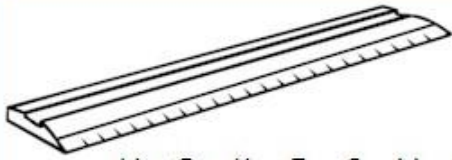

September

H Q K J S N G D U D I G I G W H Z G D D
 A R T K P Z Q V P G R N R L L K P H R F
 C N I N E O C H V A K E D Y J A Z I H B
 U I M V X I W Z F D Q N C B P W D I X D
 O D W J S Y M G N A U U E E O I O V S N
 Q Z C U B T G F L B S Q R J S U P Q R N
 H X M A I O V F H H K D X M Z S P K L A
 U J T R K K P U F Y Y S B L P Q U J S O
 H K B P A Q K M P A M L O O U T G A C N
 P H S E I M D C X F R D R V B N D Y H J
 J B H N W Y G P S J V T F B J I C D O R
 I Y P C N Q S B A U S U Z C A X M H O I
 T J P I S A F G K T B T N W K X S I L Q
 U B U L V Y V L R C T J T R X L S S G U
 L T L S R E H C A E T N O Y T C E L S R
 D J T O J P I U P K Y W Z U E D A G E O
 P O W V X F Q Q X W E N V D A D T V O A
 C Q O Y F O H E G M Q X Q R I V M H H P
 L W U Y U S E S O K D L G K J R I D W A
 N L E F R E R H M C C P A I X P R P D L

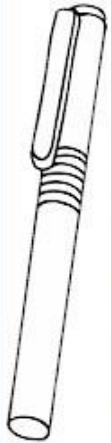

BUS GRADES
 LUNCH MUSIC
 PENCILS RECESS
 SPORTS TEACHERS
 ART
 HOMEWORK
 PAPER
 SCHOOL

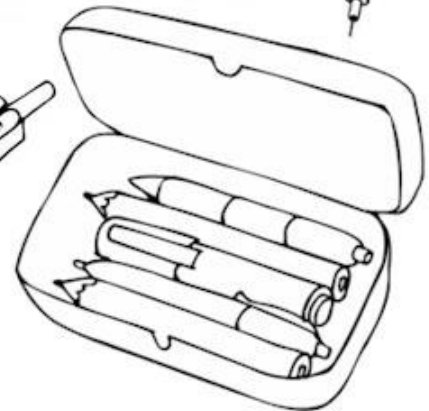
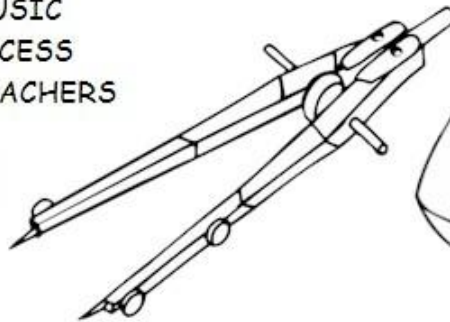

Fall Word Scramble

Unscramble the words and write the letters in the boxes. Use the letters in the shaded boxes to form a new word that answers the riddle.

ULQIT

--	--	--	--	--



LAVEES

--	--	--	--	--	--	--

BEEESTRMP

--	--	--	--	--	--	--	--	--	--

SVRTAEH



--	--	--	--	--	--	--	--

TECTHUNS

--	--	--	--	--	--	--	--	--

AUMUTN

--	--	--	--	--	--	--

ATOLFLOB

--	--	--	--	--	--	--	--	--



Q. What do you get when you drop a pumpkin?

--	--	--	--	--	--